

OMNI
MEDIKAL



fortune
medical





**ANESTHETIC
SERIES**



**GENERAL
SURGICAL
SERIES**



**GASTROENTEROLOGIC
SERIES**



**UROLOGICA
SERIES**



fortune
medical

SILICONE ENDOTRACHEAL TUBE

100% Silicone for Great Comfort and Flexibility



**ANESTHETIC
SERIES**



SILICONE ENDOTRACHEAL TUBE

Fortune[®] Silicone Endotracheal Tube is made of 100% medical grade silicone. It provides superior bio-compatibility and flexibility. Great transparency allows easy visual inspection. Graduation and X-ray opaque line help depth and location confirmation. A pilot balloon is equipped to monitor balloon status. Low pressure cuff models are available to reduce the pressure on trachea wall and to provide greater comfort to patient.

- A Silicone Endotracheal Tube, Cuffless**
- B Silicone Endotracheal Tube, OC Type**
- C Silicone Endotracheal Tube, LC Type**
- D Silicone Endotracheal Tube, OW Type**
- E Silicone Endotracheal Tube, LW Type**



SPECIFICATIONS

Endotracheal Tube, Cuffless:

| PED-Magill REF. No. | Size/I.D. | O.D. | Length | Description |
|------------------------|-----------|--------|--------|---------------------------|
| 1510-0025 | 2.5 mm | 4.0 mm | 140 mm | |
| 1510-0030 | 3.0 mm | 4.7 mm | 160 mm | Magill Series: Magill tip |
| 1510-0035 | 3.5 mm | 5.3 mm | 180 mm | Cuffless |
| 1510-0040 | 4.0 mm | 6.0 mm | 200 mm | Wire reinforced |
| 1510-0045 | 4.5 mm | 6.7 mm | 220 mm | Graduation |
| 1510-0050 | 5.0 mm | 7.3 mm | 240 mm | X-ray opaque line |



1510-00XX

SILICONE ENDOTRACHEAL TUBE

Endotracheal Tube, OC Type (Ordinary cuff, Curved):

| OC-Magill REF. No. | OC-Murphy REF. No. | Size/I.D. | O.D. | Length | Description |
|-----------------------|-----------------------|-----------|---------|--------|-------------------------------|
| 1520-0045 | 1525-0045 | 4.5 mm | 6.7 mm | 220 mm | |
| 1520-0050 | 1525-0050 | 5.0 mm | 7.3 mm | 240 mm | |
| 1520-0055 | 1525-0055 | 5.5 mm | 8.0 mm | 270 mm | |
| 1520-0060 | 1525-0060 | 6.0 mm | 8.7 mm | 280 mm | *OC-Magill series: Magill tip |
| 1520-0065 | 1525-0065 | 6.5 mm | 9.3 mm | 290 mm | *OC-Murphy series: Murphy eye |
| 1520-0070 | 1525-0070 | 7.0 mm | 10.0 mm | 300 mm | |
| 1520-0075 | 1525-0075 | 7.5 mm | 10.7 mm | 310 mm | Ordinary cuff Curved |
| 1520-0080 | 1525-0080 | 8.0 mm | 11.3 mm | 320 mm | Graduation Pilot balloon |
| 1520-0085 | 1525-0085 | 8.5 mm | 12.0 mm | 330 mm | X-ray opaque line |
| 1520-0090 | 1525-0090 | 9.0 mm | 12.7 mm | 340 mm | |
| 1520-0095 | 1525-0095 | 9.5 mm | 13.3 mm | 350 mm | |
| 1520-0100 | 1525-0100 | 10.0 mm | 14.0 mm | 360 mm | |

Endotracheal Tube, LC Type (Low pressure cuff, Curved):

| LC-Magill REF. No. | LC-Murphy REF. No. | Size/I.D. | O.D. | Length | Description |
|-----------------------|-----------------------|-----------|---------|--------|--------------------------------|
| 1530-0045 | 1535-0045 | 4.5 mm | 6.7 mm | 220 mm | |
| 1530-0050 | 1535-0050 | 5.0 mm | 7.3 mm | 240 mm | |
| 1530-0055 | 1535-0055 | 5.5 mm | 8.0 mm | 270 mm | |
| 1530-0060 | 1535-0060 | 6.0 mm | 8.7 mm | 280 mm | *LC-Magill series: Magill tip |
| 1530-0065 | 1535-0065 | 6.5 mm | 9.3 mm | 290 mm | *LC-Murphy series: Murphy eye |
| 1530-0070 | 1535-0070 | 7.0 mm | 10.0 mm | 300 mm | |
| 1530-0075 | 1535-0075 | 7.5 mm | 10.7 mm | 310 mm | Low pressure cuff Curved |
| 1530-0080 | 1535-0080 | 8.0 mm | 11.3 mm | 320 mm | Graduation Pilot balloon |
| 1530-0085 | 1535-0085 | 8.5 mm | 12.0 mm | 330 mm | X-ray opaque line |
| 1530-0090 | 1535-0090 | 9.0 mm | 12.7 mm | 340 mm | |
| 1530-0095 | 1535-0095 | 9.5 mm | 13.3 mm | 350 mm | |
| 1530-0100 | 1535-0100 | 10.0 mm | 14.0 mm | 360 mm | |

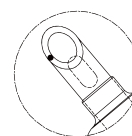
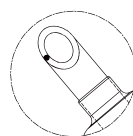
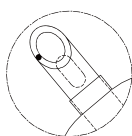
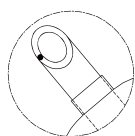
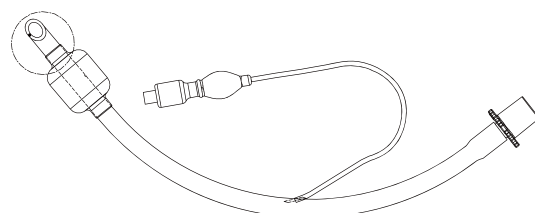
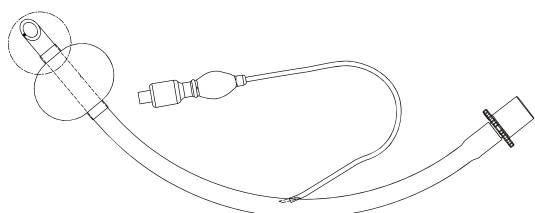

1520-OXXX

1525-OXXX

1530-OXXX

1535-OXXX

SILICONE ENDOTRACHEAL TUBE

Endotracheal Tube, OW Type (Ordinary cuff, Wire reinforced):

| OW-Magill REF. No | OW- Murphy REF. No. | Size/I.D. | O.D. | Length | Description |
|----------------------|---------------------------|-----------|---------|--------|-------------------------------------|
| 1540-0045 | 1545-0045 | 4.5 mm | 6.7 mm | 220 mm | |
| 1540-0050 | 1545-0050 | 5.0 mm | 7.3 mm | 240 mm | |
| 1540-0055 | 1545-0055 | 5.5 mm | 8.0 mm | 270 mm | |
| 1540-0060 | 1545-0060 | 6.0 mm | 8.7 mm | 280 mm | *OW-Magill series: Magill tip |
| 1540-0065 | 1545-0065 | 6.5 mm | 9.3 mm | 290 mm | *OW-Murphy series: Murphy eye |
| 1540-0070 | 1545-0070 | 7.0 mm | 10.0 mm | 300 mm | |
| 1540-0075 | 1545-0075 | 7.5 mm | 10.7 mm | 310 mm | Ordinary cuff Wire reinforced |
| 1540-0080 | 1545-0080 | 8.0 mm | 11.3 mm | 320 mm | Graduation |
| 1540-0085 | 1545-0085 | 8.5 mm | 12.0 mm | 330 mm | Pilot balloon |
| 1540-0090 | 1545-0090 | 9.0 mm | 12.7 mm | 340 mm | |
| 1540-0095 | 1545-0095 | 9.5 mm | 13.3 mm | 350 mm | |
| 1540-0100 | 1545-0100 | 10.0 mm | 14.0 mm | 360 mm | |

Endotracheal Tube, LW Type (Low pressure cuff, Wire reinforced):

| LW-Magill REF. No | LW-Murphy REF. No. | Size/I.D. | O.D. | Length | Description |
|----------------------|-----------------------|-----------|---------|--------|--|
| 1550-0045 | 1555-0045 | 4.5 mm | 6.7 mm | 220 mm | |
| 1550-0050 | 1555-0050 | 5.0 mm | 7.3 mm | 240 mm | |
| 1550-0055 | 1555-0055 | 5.5 mm | 8.0 mm | 270 mm | *LW-Magill series: Magill tip |
| 1550-0060 | 1555-0060 | 6.0 mm | 8.7 mm | 280 mm | *LW-Murphy series: Murphy eye |
| 1550-0065 | 1555-0065 | 6.5 mm | 9.3 mm | 290 mm | |
| 1550-0070 | 1555-0070 | 7.0 mm | 10.0 mm | 300 mm | |
| 1550-0075 | 1555-0075 | 7.5 mm | 10.7 mm | 310 mm | Low pressure cuff Wire reinforced |
| 1550-0080 | 1555-0080 | 8.0 mm | 11.3 mm | 320 mm | Graduation |
| 1550-0085 | 1555-0085 | 8.5 mm | 12.0 mm | 330 mm | Pilot balloon |
| 1550-0090 | 1555-0090 | 9.0 mm | 12.7 mm | 340 mm | |
| 1550-0095 | 1555-0095 | 9.5 mm | 13.3 mm | 350 mm | |
| 1550-0100 | 1555-0100 | 10.0 mm | 14.0 mm | 360 mm | |

O: ordinary cuff, L: low pressure cuff, W: wire reinforced

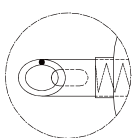
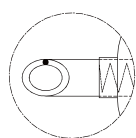
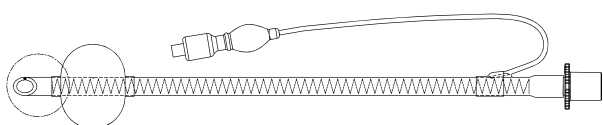

1540-OXXX:LW-MAGILL

1545-OXXX:LW-MYRPHY

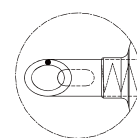
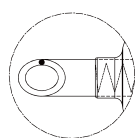
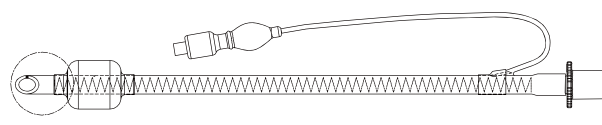

1550-OXXX:LW-MAGILL

1555-OXXX:LW-MYRPHY

TRACHEAL TUBE FIXATION DEVICE

INTENDED USE:

The Fortune tracheal tube fixation device (hereinafter referred to as the fixer) is intended to be used to secure a tracheal tube in an appropriate position. It is easy to operate and enhances patient comfort.

FEATURES:

1. Easy to operate: quick to mount; efficiently prevents biting of the tube.
2. The anti-ulceration pad reduces the risk of ulcerated lips.
3. Smaller and shorter than artificial airways, the fixer's small size reduces the risk of damage to the patient's oral cavity.
4. The fixer's adjustable strap reduces the risk of skin damage. The strap is designed with patient comfort in mind.

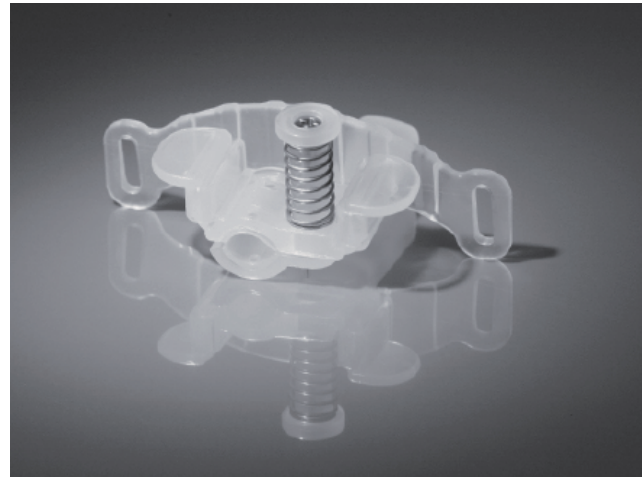

• Patented design wins 2013 Taipei Int'l Invention Show & Technomart Gold Medal Award

SPECIFICATIONS

Designed to match tracheal tubes with outer diameter (O.D.) from 8.0 mm to 12.0 mm.

| Fortune Tracheal tube | size | O.D. (mm) | I.D. (mm) |
|------------------------------|-----------|-----------|-----------|
| | 0060 26FR | 8.7 | 6.0 |
| 1520 series, 1525 series, | 0065 28FR | 9.3 | 6.5 |
| 1530 series, 1535 series, | 0070 30FR | 10.0 | 7.0 |
| 1540 series, 1545 series, | 0075 32FR | 10.7 | 7.5 |
| 1550 series, 1555 series. | 0080 34FR | 11.3 | 8.0 |
| | 0085 36FR | 12.0 | 8.5 |
| | 0090 38FR | 12.7 | 9.0 |

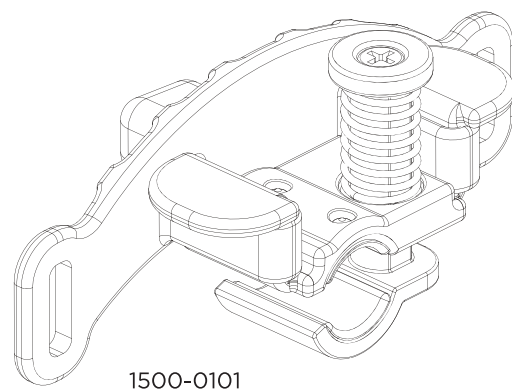



SILICONE TRACHEOSTOMY TUBE

100% Silicone for Enhanced Patient Comfort and
Great Biocompatibility



ANESTHETIC
SERIES



SILICONE TRACHEOSTOMY TUBE

Fortune[®] Silicone Tracheostomy Tube Features:

- 100% medical grade silicone for superior
- biocompatibility.
- Curved smooth tube and mounted Obturator for easy insertion.
- Standard 15 mm connector.
- X-ray opaque line.
- All cuff models comes with a sensitive pilot balloon allows confirmation of the cuff status.
- Low pressure cuff model provides minimum pressure against trachea wall.
- Neck strap for fixation.
- 15 mm Disconnect Wedge.
- Sterilized double packaging.

- A** Tracheostomy Tube, Cuffless
- B** Tracheostomy Tube, OC Type
- C** Tracheostomy Tube, LC Type
- D** Disconnect Wedge
- E** Neck Strap



SPECIFICATIONS

Disconnect Wedge:

| REF. No. | Size | Description |
|-----------|-------|--------------------------------|
| 1500-0000 | 15 mm | For disconnect 15 mm connector |



1500-0000

Neck Strap:

| REF. No. | Size | Description |
|-----------|-----------|--------------------|
| 1550-0001 | Universal | Soft fabric Velcro |



1550-0001

Silicone Tracheostomy Tube, Cuffless:

| Product | REF. No. | Size / I.D. | O.D. | Length | Description |
|------------------------------------|-----------|-------------|---------|---------|-------------------|
| | 1561-0050 | 5.0 mm | 7.3 mm | 60.0 mm | |
| | 1561-0055 | 5.5 mm | 8.0 mm | 62.5 mm | |
| | 1561-0060 | 6.0 mm | 8.7 mm | 65.0 mm | |
| | 1561-0065 | 6.5 mm | 9.3 mm | 67.5 mm | Cuffless |
| Tracheostomy Tube, Cuffless | 1561-0070 | 7.0 mm | 10.0 mm | 70.0 mm | X-ray opaque line |
| | 1561-0075 | 7.5 mm | 10.7 mm | 72.5 mm | Obturator |
| | 1561-0080 | 8.0 mm | 11.3 mm | 75.0 mm | Neck strap |
| | 1561-0085 | 8.5 mm | 12.0 mm | 77.5 mm | Disconnect wedge |
| | 1561-0090 | 9.0 mm | 12.7 mm | 80.0 mm | |
| | 1561-0095 | 9.5 mm | 13.3 mm | 82.5 mm | |
| | 1561-0100 | 10.0 mm | 14.0 mm | 85.0 mm | |

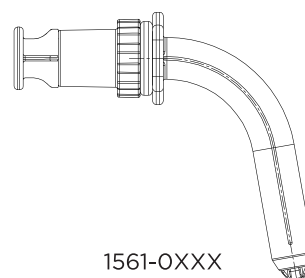

1561-OXXX

SILICONE TRACHEOSTOMY TUBE

Silicone Tracheostomy, OC Type:

| Product | REF. No. | Size / I.D. | O.D. | Length | Description |
|-----------------------------------|-----------|-------------|---------|---------|----------------------|
| | 1560-0050 | 5.0 mm | 7.3 mm | 60.0 mm | |
| | 1560-0055 | 5.5 mm | 8.0 mm | 62.5 mm | |
| | 1560-0060 | 6.0 mm | 8.7 mm | 65.0 mm | |
| | 1560-0065 | 6.5 mm | 9.3 mm | 67.5 mm | Ordinary Cuff |
| Tracheostomy Tube, OC Type | 1560-0070 | 7.0 mm | 10.0 mm | 70.0 mm | X-ray opaque line |
| | 1560-0075 | 7.5 mm | 10.7 mm | 72.5 mm | Obturator |
| | 1560-0080 | 8.0 mm | 11.3 mm | 75.0 mm | Neck strap |
| | 1560-0085 | 8.5 mm | 12.0 mm | 77.5 mm | Disconnect wedge |
| | 1560-0090 | 9.0 mm | 12.7 mm | 80.0 mm | |
| | 1560-0095 | 9.5 mm | 13.3 mm | 82.5 mm | |
| | 1560-0100 | 10.0 mm | 14.0 mm | 85.0 mm | |

Silicone Tracheostomy, LC Type:

| Product | REF. No. | Size / I.D. | O.D. | Length | Description |
|-----------------------------------|-----------|-------------|---------|---------|--------------------------|
| | 1565-0050 | 5.0 mm | 7.3 mm | 60.0 mm | |
| | 1565-0055 | 5.5 mm | 8.0 mm | 62.5 mm | |
| | 1565-0060 | 6.0 mm | 8.7 mm | 65.0 mm | |
| | 1565-0065 | 6.5 mm | 9.3 mm | 67.5 mm | Low Pressure Cuff |
| Tracheostomy Tube, LC Type | 1565-0070 | 7.0 mm | 10.0 mm | 70.0 mm | X-ray opaque line |
| | 1565-0075 | 7.5 mm | 10.7 mm | 72.5 mm | Obturator |
| | 1565-0080 | 8.0 mm | 11.3 mm | 75.0 mm | Neck strap |
| | 1565-0085 | 8.5 mm | 12.0 mm | 77.5 mm | Disconnect wedge |
| | 1565-0090 | 9.0 mm | 12.7 mm | 80.0 mm | |
| | 1565-0095 | 9.5 mm | 13.3 mm | 82.5 mm | |
| | 1565-0100 | 10.0 mm | 14.0 mm | 85.0 mm | |

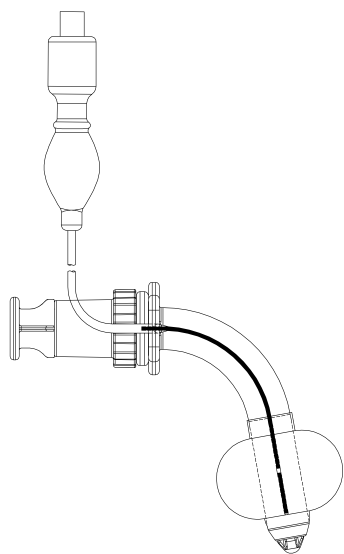

1560-OXXX

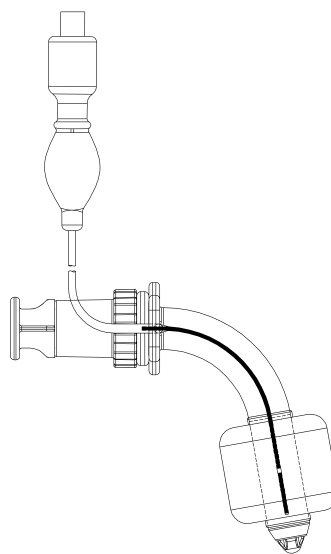

1565-OXXX



SILICONE PENROSE DRAIN TUBE



GENERAL
SURGICAL
SERIES



SILICONE PENROSE DRAIN TUBE

Fortune[®] Silicone Penrose Drainage Tube are used for post-operative drainage. Soft and smooth tube minimizes trauma during insertion and withdrawal, the tube draws the fluids to the exterior using the capillary phenomenon. Transparent tube with X-ray opaque line allows for easy visual inspection, fluid observation, and also confirmation of intubated tube using X-ray; white tube has X-ray opaque effectiveness throughout the entire length. Secure-Clip provides the tube an easy fixation on the wound site.

Three types of Penrose are available for selection:

- Penrose Drain Tube
- Penrose Drain Tube w/ Secure-Clip
- Penrose Straight Drain Tube

- A Silicone Penrose Drain Tube**
- B Silicone Penrose Drain Tube w/ Secure-Clip**
- C Secure-Clip**
- D Silicone Penrose Straight Drain Tube**

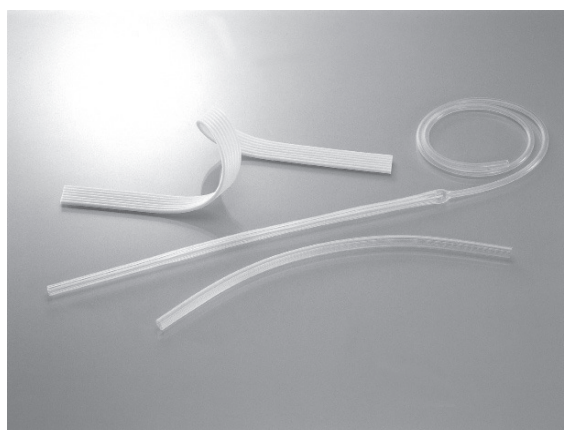

SPECIFICATIONS

Penrose Drain Tube w/ Secure-Clip:

| REF. No. | O.D. | Description |
|-----------|-------|---|
| 2010-5405 | 5 mm | |
| 2010-5406 | 6 mm | |
| 2010-5408 | 8 mm | WS-type 300 mm |
| 2010-5410 | 10 mm | White opaque effectiveness Secure-clip |
| 2010-5412 | 12 mm | Graduation |
| 2010-5415 | 15 mm | |
| 2010-5419 | 19 mm | |
| 2010-5425 | 25 mm | |

| REF. No. | O.D. | Description |
|-----------|-------|---|
| 2010-6405 | 5 mm | |
| 2010-6406 | 6 mm | |
| 2010-6408 | 8 mm | WS-type 500 mm |
| 2010-6410 | 10 mm | White opaque effectiveness Secure-clip |
| 2010-6412 | 12 mm | Graduation |
| 2010-6415 | 15 mm | |
| 2010-6419 | 19 mm | |
| 2010-6425 | 25 mm | |

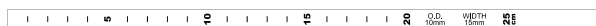

2010-54XX/64XX

SILICONE PENROSE DRAIN TUBE

Penrose Drain Tube:

| REF. No. | O.D. | Description |
|-----------|-------|-------------------|
| 2010-0405 | 5 mm | |
| 2010-0406 | 6 mm | |
| 2010-0408 | 8 mm | S-type |
| 2010-0410 | 10 mm | 300 mm |
| 2010-0412 | 12 mm | Transparent |
| | | X-ray opaque line |
| 2010-0415 | 15 mm | |
| 2010-0419 | 19 mm | |
| 2010-0425 | 25 mm | |
| 2010-1405 | 5 mm | |
| 2010-1406 | 6 mm | |
| 2010-1408 | 8 mm | S-type |
| 2010-1410 | 10 mm | 500 mm |
| 2010-1412 | 12 mm | Transparent |
| | | X-ray opaque line |
| 2010-1415 | 15 mm | |
| 2010-1419 | 19 mm | |
| 2010-1425 | 25 mm | |

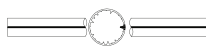

2010-04XX/14XX

Penrose Straight Drain Tube:

| REF. No. | Size | Width | Length | Description |
|-----------|------|-------|--------|----------------------------|
| 2011-0020 | S | 20 mm | | |
| 2011-0025 | M | 25 mm | 400 mm | X-ray opaque effectiveness |
| 2011-0035 | L | 35 mm | | |
| 2011-0045 | XL | 45 mm | | |



2011-0020



2011-0025



2011-0035

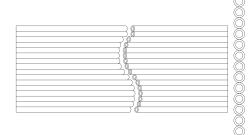

2011-0045

Secure-Clip:

| REF. No. | Size | Description |
|-----------|-----------|-------------|
| 2010-0000 | Universal | Metal |



2010-0000



SILICONE T DRAINAGE TUBE

Choices for alternative drainage



**GENERAL
SURGICAL
SERIES**



SILICONE T DRAINAGE TUBE

Fortune[®] Silicone T Drainage Tube Feature:

- 100% medical grade silicone for superior biocompatibility.
- Proper rigidity design to prevent from kink or clog over time.
- Larger diameter of connecting tube allows smooth withdrawn.
- X-ray opaque line.
- Sterilized double packaging.

A Silicone T Drainage Tube

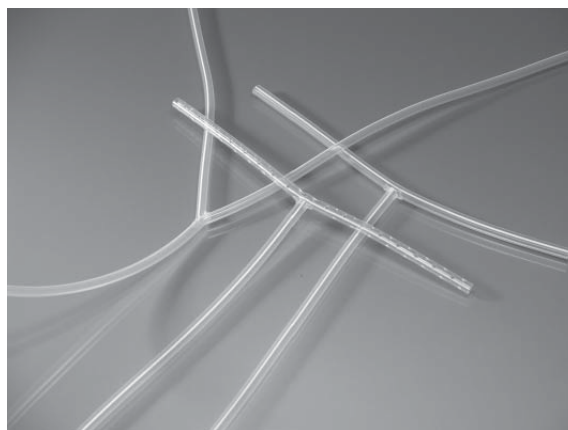

SPECIFICATIONS

T Drainage Tube:

| REF. No. | Size | Description |
|-----------|-------|---|
| 1910-0005 | 5 FR | |
| 1910-0008 | 8 FR | |
| 1910-0010 | 10 FR | |
| 1910-0012 | 12 FR | A: 180 mm |
| 1910-0014 | 14 FR | B: 450 mm |
| 1910-0016 | 16 FR | X-ray opaque line w/large bore male connector |
| 1910-0018 | 18 FR | |
| 1910-0020 | 20 FR | |
| 1910-0022 | 22 FR | |
| 1910-0024 | 24 FR | |

T Drainage Tube With Eyes:

| REF. No. | Size | Description |
|-----------|-------|---|
| 1910-0210 | 10 FR | |
| 1910-0212 | 12 FR | |
| 1910-0214 | 14 FR | Perforation A: 180 mm |
| 1910-0216 | 16 FR | B: 450 mm |
| 1910-0218 | 18 FR | X-ray opaque line w/large bore male connector |
| 1910-0220 | 20 FR | |
| 1910-0222 | 22 FR | |
| 1910-0224 | 24 FR | |

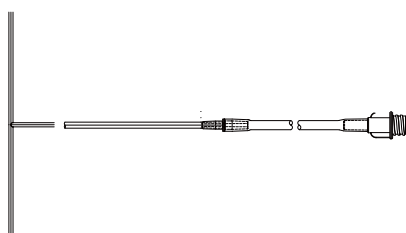

1910-00XX

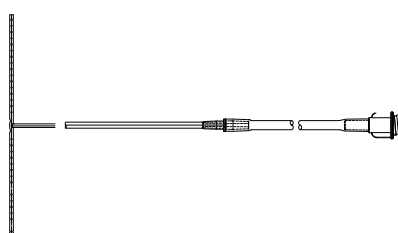

1910-02XX

SILICONE T DRAINAGE TUBE

T Drainage Set:

| REF. No. | Size | Description |
|-----------|-------|-----------------------|
| 1910-4005 | 5 FR | |
| 1910-4008 | 8 FR | T Drainage Tube |
| 1910-4010 | 10 FR | Connector |
| | | 400 cc Collection Bag |
| 1910-8012 | 12 FR | |
| 1910-8014 | 14 FR | |
| 1910-8016 | 16 FR | |
| 1910-8018 | 18 FR | |
| 1910-8020 | 20 FR | T Drainage Tube |
| | | Connector |
| 1910-8022 | 22 FR | 800 cc Collection Bag |
| 1910-8024 | 24 FR | |

T Drainage Set With Eyes:

| REF. No. | Size | Description |
|-----------|-------|---------------------------|
| 1910-8212 | 12 FR | |
| 1910-8214 | 14 FR | |
| 1910-8216 | 16 FR | T Drainage Tube With Eyes |
| 1910-8218 | 18 FR | Connector |
| | | 800 cc Collection Bag |
| 1910-8220 | 20 FR | |
| 1910-8222 | 22 FR | |
| 1910-8224 | 24 FR | |

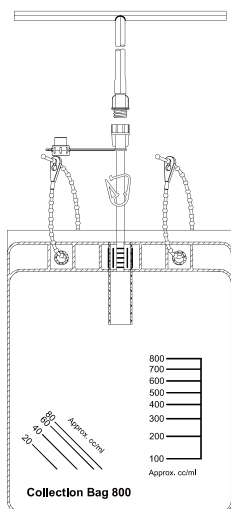

1910-80XX

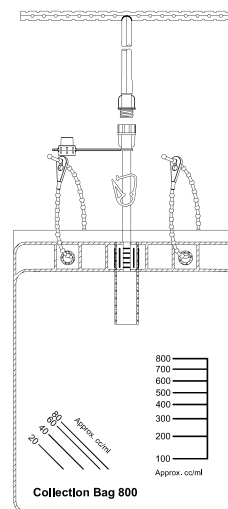

1910-82XX



GASTROSTOMY CATHETER

100% Silicone for Enhanced Patient Comfort



**GASTROENTEROLOGIC
SERIES**



GASTROSTOMY CATHETER

Fortune® Silicone Gastrostomy Catheter:

- 100% medical grade silicone for superior biocompatibility.
- Proper softness and excellent flexibility for enhanced patient comfort.
- Transparent tube allows for easy visual inspection. Radiopaque allows for confirmation the position of tube.
- Depth marking for identification of the tube position.
- Wide open-rounded end improves flow and minimizes trauma on insertion.
- Shortened tip design reduces gastric mucosa irritation.
- Funnel with several inner sealing o-ring for other device connecting universally.
- Attached plug for secured sealing to avoid air entering and contamination.
- External Bolster prevents tube migration and eliminates the needs for tape or suture.
- It is not easily visible when wearing normal clothes and is more comfortable.
- Universal medication port.
- Latex/DEHP free.

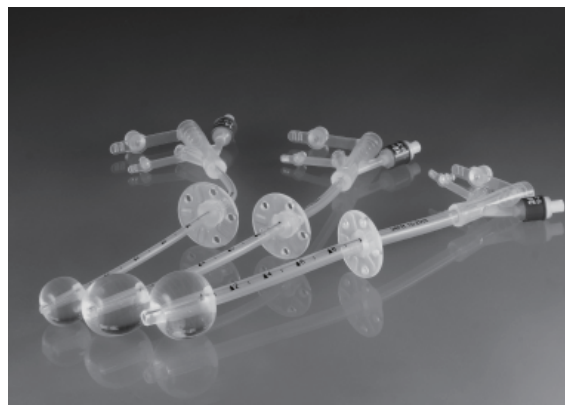

SPECIFICATIONS

Gastrostomy Catheter:

| REF. No. | Size. | Balloon volume | Length | Depth marking | X-RAY | Bolster |
|-----------|-------|----------------|--------|---------------|-------|---------|
| 2019-0012 | 12FR | 5-10cc | | | | |
| 2019-0014 | 14FR | | | | | |
| 2019-0016 | 16FR | 10-20cc | | 2 | | |
| 2019-0018 | 18FR | | | 4 | | |
| 2019-0020 | 20FR | | 255 mm | 6 | yes | yes |
| 2019-0022 | 22FR | 15-20cc | | 8 | | |
| 2019-0024 | 24FR | | | 10 | | |
| 2019-0026 | 26FR | | | cm | | |
| 2019-0028 | 28FR | | | | | |

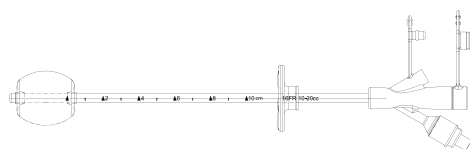

2019-00XX



SILICONE HEMATURIA CATHETER

Your Right Choice for Quality Catheters



UROLOGICAL
SERIES



SILICONE HEMATURIA CATHETER

Fortune® Silicone 3-Way Hematuria Catheter Features:

- 100% medical grade silicone for superior biocompatibility.
- Transparent tube allows easy visual inspection and fluid observation.
- X-ray opaque line allows intubating location confirmation.
- A soft and uniformly inflated larger volume balloon makes the tube sit well against the bladder.
- 3-Way design with an attached plug on the irrigation funnel.
- Tapered Central funnel could be connected with irrigation bags.
- Five types are available for various applications:
 - A. type: Straight round tip
 - B. type: Straight whistle tip
 - C. type: Coude round tip
 - D. type: Dufour
 - E. type: Couvelaire
- Sterilized double packaging.

- A** Silicone Hematuria Catheter, Straight Round Tip
- B** Silicone Hematuria Catheter, Straight Whistle Tip
- C** Silicone Hematuria Catheter, Coude Round Tip
- D** Silicone Hematuria Catheter, Dufour
- E** Silicone Hematuria Catheter, Couvelaire



SPECIFICATIONS

Hematuria Catheter, Straight Round Tip:

| REF. No. | Size | Balloon | Length | Description |
|-----------|-------|----------|--------|--------------------|
| 1861-0318 | 18 FR | 50-80cc | | Straight round tip |
| 1861-0320 | 20 FR | | 420 mm | X-ray opaque line |
| 1861-0322 | 22 FR | 80-100cc | | Attached plug |
| 1861-0324 | 24 FR | | | Catheter spigot |

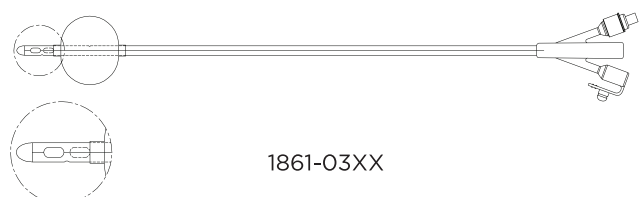

SILICONE HEMATURIA CATHETER

Hematuria Catheter, Straight Whistle Tip:

| REF. No. | Size | Balloon | Length | Description |
|-----------|-------|-----------|--------|---|
| 1862-0318 | 18 FR | 50-80 cc | 420 mm | Straight whistle tip X-ray opaque line Attached plug Catheter spigot |
| 1862-0320 | 20 FR | | | |
| 1862-0322 | 22 FR | 80-100 cc | | |
| 1862-0324 | 24 FR | | | |

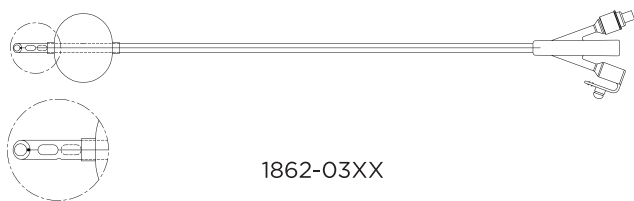

1862-03XX

Hematuria Catheter, Coude Round Tip:

| REF. No. | Size | Balloon | Length | Description |
|-----------|-------|-----------|--------|--|
| 1863-0318 | 18 FR | 50-80 cc | 420 mm | Coude round tip X-ray opaque line Attached plug Catheter spigot |
| 1863-0320 | 20 FR | | | |
| 1863-0322 | 22 FR | 80-100 cc | | |
| 1863-0324 | 24 FR | | | |

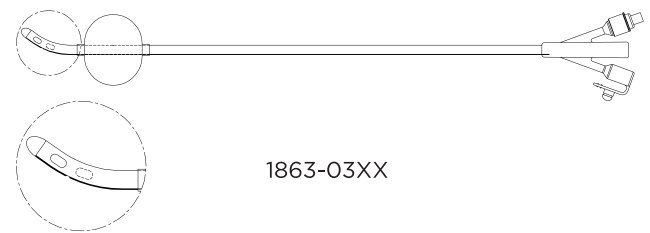

1863-03XX

Hematuria Catheter, Dufour:

| REF. No. | Size | Balloon | Length | Description |
|-----------|-------|-----------|--------|---|
| 1864-0318 | 18 FR | 50-80 cc | 420 mm | Dufour X-ray opaque line Attached plug Catheter spigot |
| 1864-0320 | 20 FR | | | |
| 1864-0322 | 22 FR | 80-100 cc | | |
| 1864-0324 | 24 FR | | | |

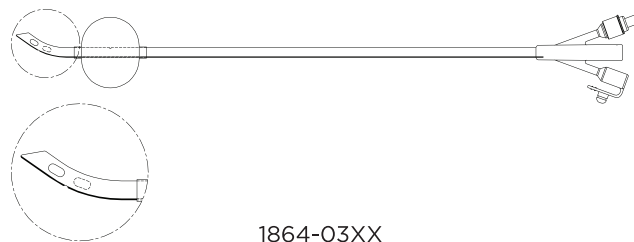

1864-03XX

Hematuria Catheter, Couvelaire:

| REF. No. | Size | Balloon | Length | Description |
|-----------|-------|-----------|--------|---|
| 1865-0318 | 18 FR | 50-80 cc | 420 mm | Couvelaire X-ray opaque line Attached plug Catheter spigot |
| 1865-0320 | 20 FR | | | |
| 1865-0322 | 22 FR | 80-100 cc | | |
| 1865-0324 | 24 FR | | | |



1865-03XX



SILICONE NEPHROSTOMY CATHETER

The Right Choice for Quality Catheters



UROLOGICAL
SERIES



SILICONE NEPHROSTOMY CATHETER

Fortune[®] Silicone Nephrostomy Catheter Features:

- 100% medical grade silicone for superior biocompatibility.
- Transparent tube with X-ray opaque line. It allows for easy visual inspection and fluid observation. It also allows for confirmation of intubated tube using X-ray.
- Soft and uniformly inflated balloon makes the tube sit well against the kidney.
- Smooth round shaft can minimize trauma during insertion and withdrawal.
- Four types available for different applications.
- Sterilized double packaging



SPECIFICATIONS

Nephrostomy Catheter, X-ray Opaque Tip, 2 Sided Holes:

| Ordinary Balloon REF. No. | Integrated Balloon REF. No. | Size | Balloon | Length | Description |
|---------------------------|-----------------------------|-------|---------|--------|--|
| 1851-0208 | -- | 8 FR | 1.5 cc | | |
| 1851-0210 | -- | 10 FR | | | |
| 1851-0212 | 4851-0212 | 12 FR | 2 cc | | |
| 1851-0214 | 4851-0214 | 14 FR | 3 cc | | X-ray opaque tip 2 sided holes Depth marking |
| 1851-0216 | 4851-0216 | 16 FR | | 420 mm | X-ray opaque line |
| 1851-0218 | 4851-0218 | 18 FR | | | Catheter spigot |
| 1851-0220 | 4851-0220 | 20 FR | 5 cc | | |
| 1851-0222 | 4851-0222 | 22 FR | | | |
| 1851-0224 | 4851-0224 | 24 FR | | | |

Nephrostomy Catheter, Open Tip:

| Ordinary Balloon REF. No. | Integrated Balloon REF. No. | Size | Balloon | Length | Description |
|---------------------------|-----------------------------|-------|---------|--------|---------------------------|
| 1852-0208 | -- | 8 FR | 1.5 cc | | |
| 1852-0210 | -- | 10 FR | | | |
| 1852-0212 | 4852-0212 | 12 FR | 2 cc | | |
| 1852-0214 | 4852-0214 | 14 FR | 3 cc | | Open tip Depth marking |
| 1852-0216 | 4852-0216 | 16 FR | | 420 mm | X-ray opaque line |
| 1852-0218 | 4852-0218 | 18 FR | | | Catheter spigot |
| 1852-0220 | 4852-0220 | 20 FR | 5 cc | | |
| 1852-0222 | 4852-0222 | 22 FR | | | |
| 1852-0224 | 4852-0224 | 24 FR | | | |



1851-02XX



1852-02XX

SILICONE NEPHROSTOMY CATHETER

Nephrostomy Catheter, Open Tip, 2 Sided Holes:

| Ordinary Balloon REF. No. | Integrated Balloon REF. No. | Size | Balloon | Length | Description |
|---------------------------|-----------------------------|-------|---------|--------|--|
| 1853-0208 | -- | 8 FR | 1.5 cc | | |
| 1853-0210 | -- | 10 FR | | | |
| 1853-0212 | 4853-0212 | 12 FR | 2 cc | | |
| 1853-0214 | 4853-0214 | 14 FR | 3 cc | | Open tip 2 sided holes Depth marking |
| 1853-0216 | 4853-0216 | 16 FR | | 330 mm | X-ray opaque line |
| 1853-0218 | 4853-0218 | 18 FR | | | Catheter spigot |
| 1853-0220 | 4853-0220 | 20 FR | 5 cc | | |
| 1853-0222 | 4853-0222 | 22 FR | | | |
| 1853-0224 | 4853-0224 | 24 FR | | | |

Nephrostomy Catheter, Open Tip, 2 Sided Holes:

| Ordinary Balloon REF. No. | Integrated Balloon REF. No. | Size | Balloon | Length | Description |
|---------------------------|-----------------------------|-------|---------|--------|--|
| 1854-0208 | -- | 8 FR | 1.5 cc | | |
| 1854-0210 | -- | 10 FR | | | |
| 1854-0212 | 4854-0212 | 12 FR | 2 cc | | |
| 1854-0214 | 4854-0214 | 14 FR | 3 cc | | Open tip 2 sided holes Depth marking |
| 1854-0216 | 4854-0216 | 16 FR | | 420 mm | X-ray opaque line |
| 1854-0218 | 4854-0218 | 18 FR | | | Catheter spigot |
| 1854-0220 | 4854-0220 | 20 FR | 5 cc | | |
| 1854-0222 | 4854-0222 | 22 FR | | | |
| 1854-0224 | 4854-0224 | 24 FR | | | |



1853-02XX



1854-02XX



SILICONE SUPRA-PUBIC CATHETER

Quality, Safety & Reliability Guaranteed



UROLOGICAL
SERIES



SILICONE SUPRA-PUBIC CATHETER

Fortune® Silicone Supra-Pubic Catheter Features:

- 100% medical grade silicone for superior biocompatibility.
- Transparent with X-ray opaque line.
- Integrated balloon for smooth insertion through split cannula or surgical procedure.
- Smooth round shaft minimize trauma during insertion and withdrawal.
- Pigtail pattern available for enhanced drainage.
- Sterilized double packaging.

- A Silicone Supra-pubic Catheter**
- B Silicone Supra-Pubic Catheter Puncture Set**
- C Silicone Supra-Pubic Catheter Exchange Set**

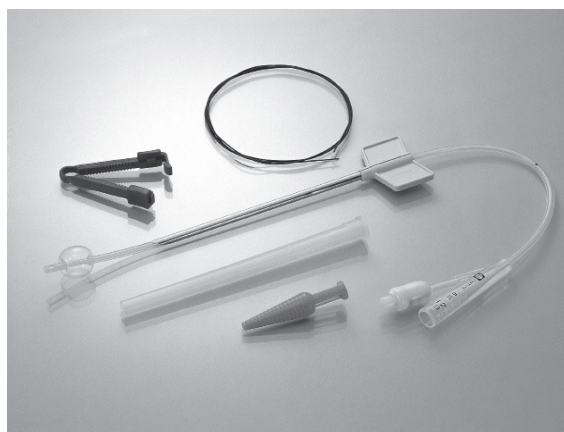

SPECIFICATIONS

Supra-pubic Catheter:

| Ordinary Balloon REF. No. | Integrated Balloon REF. No. | Size | Balloon | Length | Description |
|---------------------------|-----------------------------|-------|---------|--------|----------------------------------|
| 1890-0212 | 4890-0212 | 12 FR | | | |
| 1890-0214 | 4890-0214 | 14 FR | | | |
| 1890-0216 | 4890-0216 | 16 FR | | | |
| 1890-0218 | 4890-0218 | 18 FR | 5-10 cc | 420 mm | Depth marking Catheter spigot |
| 1890-0220 | 4890-0220 | 20 FR | | | |
| 1890-0222 | 4890-0222 | 22 FR | | | |
| 1890-0224 | 4890-0224 | 24 FR | | | |



1890-02XX

Supra-pubic Catheter:

| Ordinary Balloon REF. No. | Integrated Balloon REF. No. | Size | Balloon | Length | Description |
|---------------------------|-----------------------------|-------|---------|--------|---|
| 1857-0212 | | 12 FR | | | |
| 1857-0214 | N/A | 14 FR | 5-10 cc | 500 mm | Pigtail pattern Depth marking Catheter spigot |
| 1857-0216 | | 16 FR | | | |



1857-02XX

SILICONE SUPRA-PUBIC CATHETER

Supra-Pubic Catheter Puncture Set:

| REF. No. | Size | Balloon | Length | Description |
|-----------|-------|---------|--------|--------------------|
| 4890-9212 | 12 FR | 5-10 cc | 420 mm | Integrated balloon |
| | | | | Split cannula |
| | | | | Depth marking |
| | | | | Catheter spigot |
| 4890-9214 | 14 FR | | | Catheter clamp |

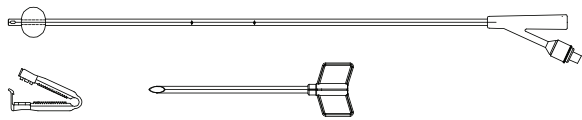

4890-92XX

Supra-Pubic Catheter Exchange Set:

| Ordinary Balloon REF. No. | Integrated Balloon REF. No. | Size | Balloon | Length | Description |
|---------------------------|-----------------------------|-------|---------|--------|------------------------------|
| 1890-8212 | 4890-8212 | 12 FR | | | |
| 1890-8214 | 4890-8214 | 14 FR | | | |
| 1890-8216 | 4890-8216 | 16 FR | | | |
| 1890-8218 | 4890-8218 | 18 FR | 5-10 cc | 420 mm | Depth marking |
| 1890-8220 | 4890-8220 | 20 FR | | | Catheter spigot |
| 1890-8222 | 4890-8222 | 22 FR | | | Catheter clamp |
| 1890-8224 | 4890-8224 | 24 FR | | | PTFE coated guidewire 0.035" |

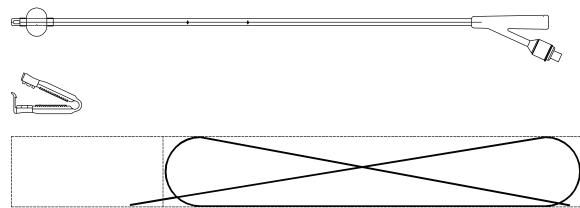

1890-82XX

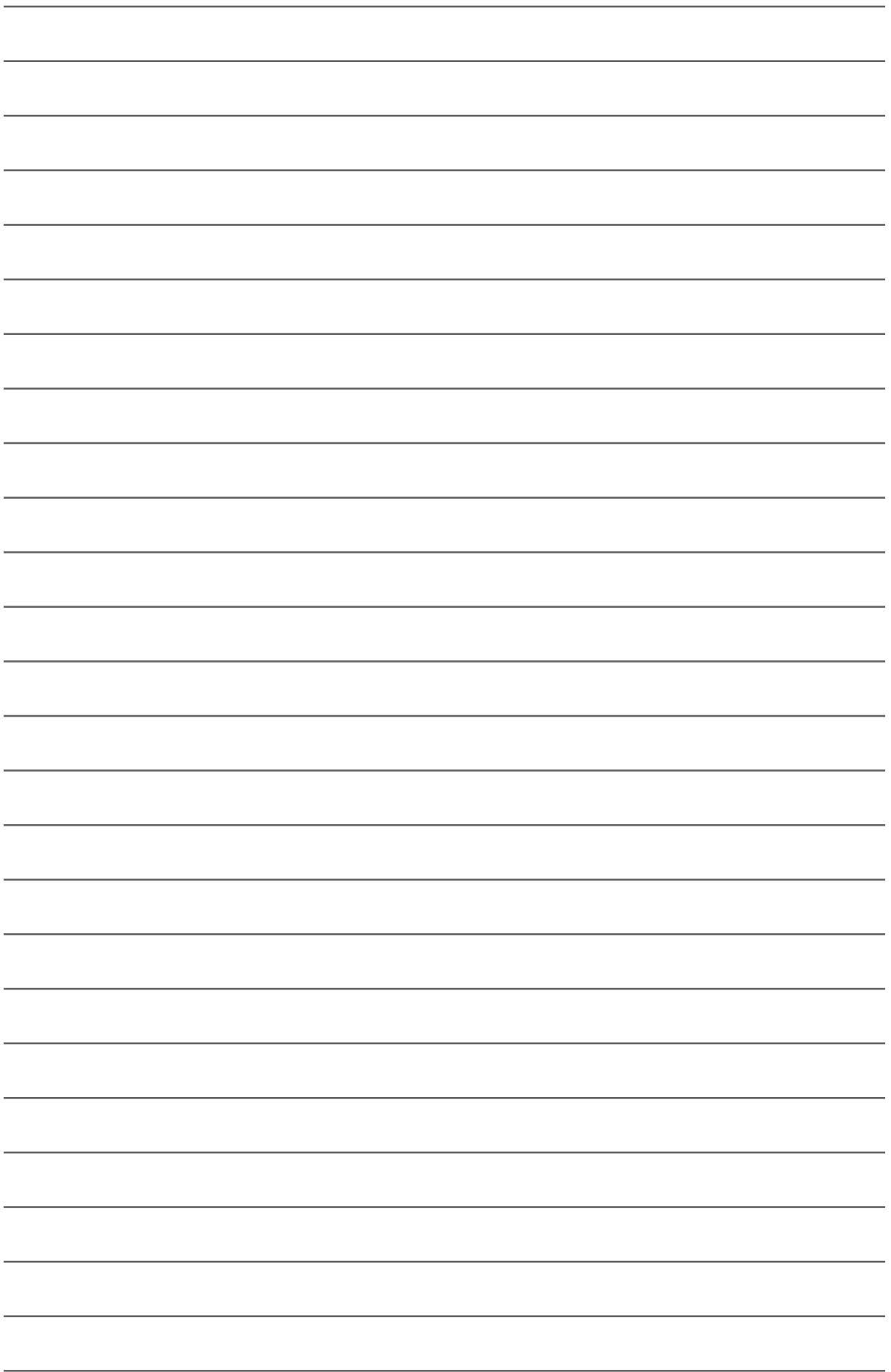

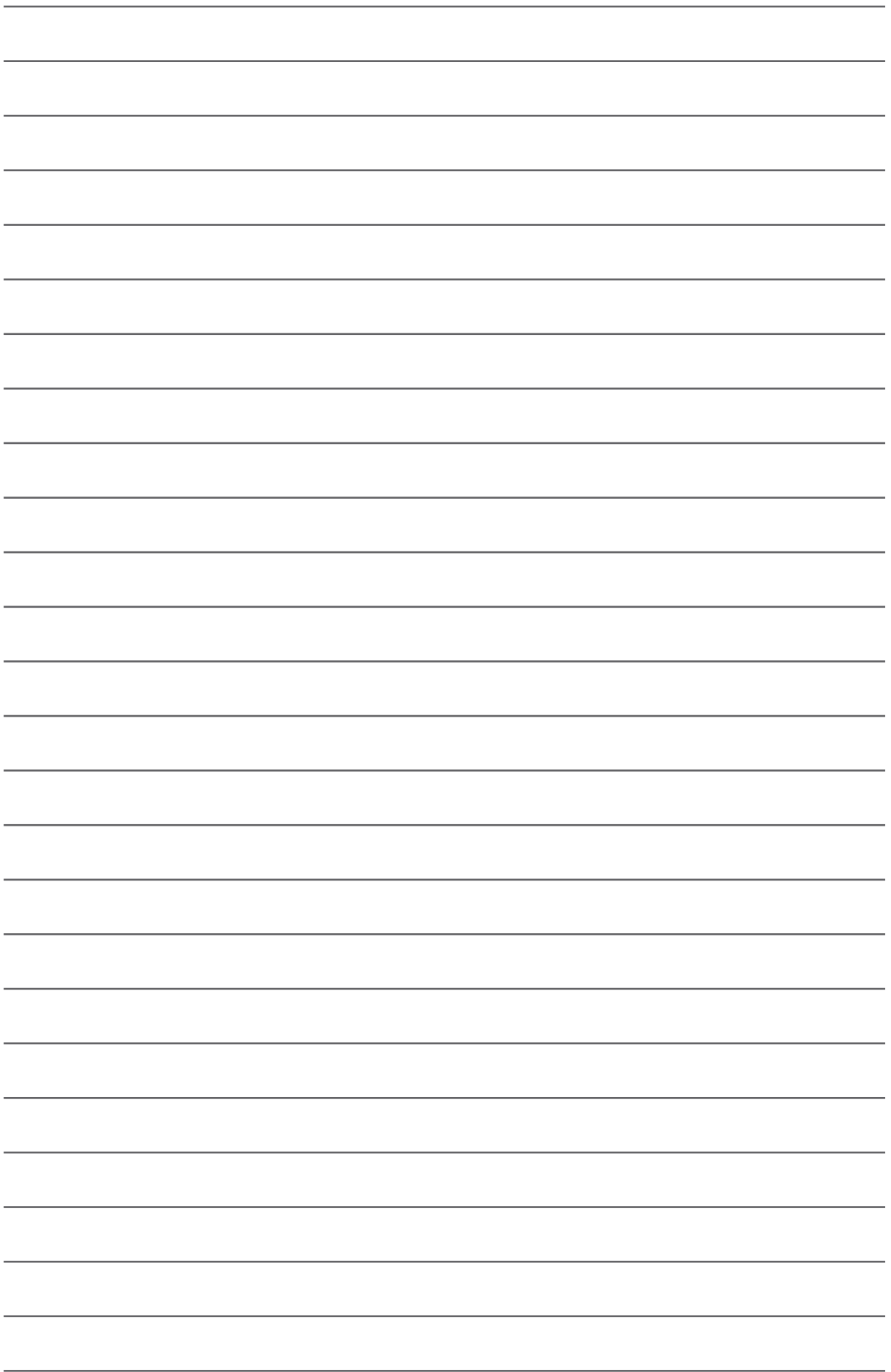

GENERALNI UVOZNIK I DISTRIBUTER



OMNI MEDIKAL d.o.o.
Auto put br. 13, Blok 53
11070 Novi Beograd, Srbija
tel.: +381 11 3730085
fax: +381 11 3730090
contact@omni-med.net